

Hadrozaur Hadrosaur

by A. F. Pełlewski © 2004

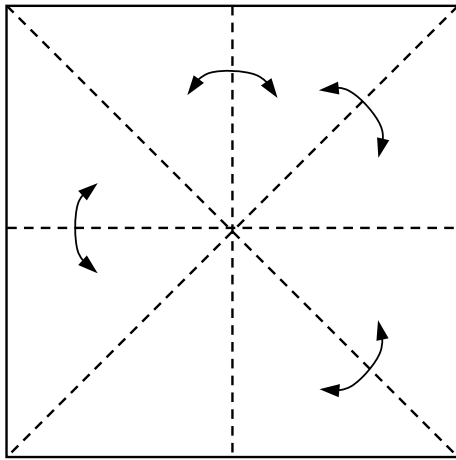

1. Zrób zgięcia.
Make creases.

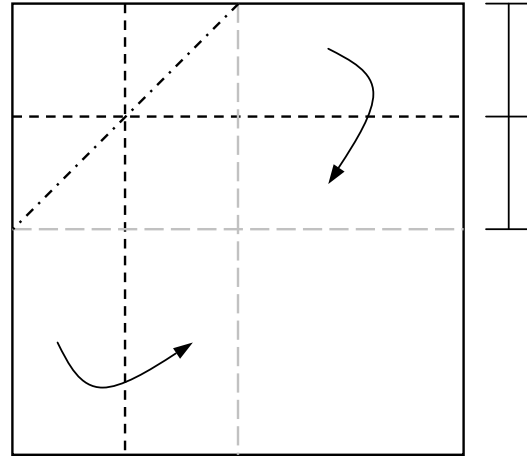

2. Zegnij do środka tworząc z rogu kwadrat.
Fold to the center. Create a square in the corner.

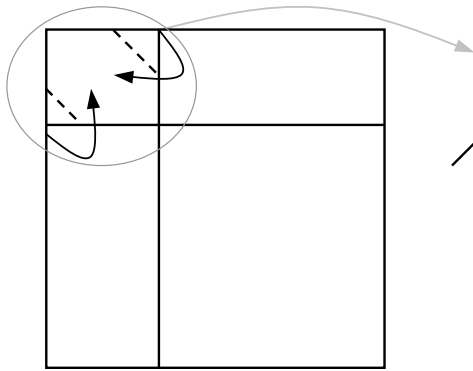

3. Zegnij do środka.
Fold to the center.

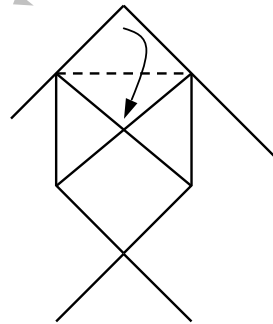

4. Zegnij i rozprostuj całość.
Fold the upper triangle and then open the square out.

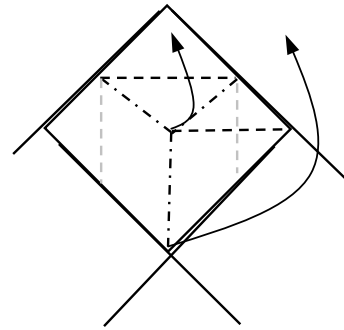

5. Zegnij tworząc podwójny trójkąt u góry.
Fold forming a double triangle at the upper part.

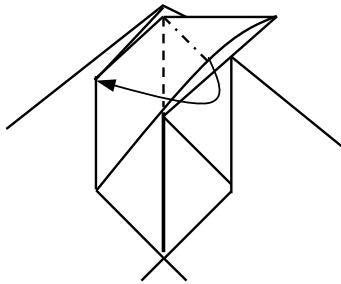

6. Rozłóż.
Spread.

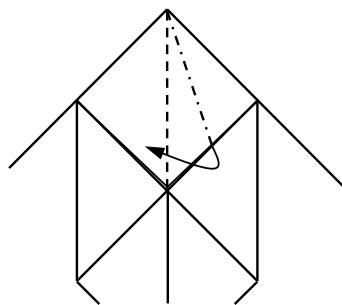

7. Powtórnie rozłóż.
Spread again.

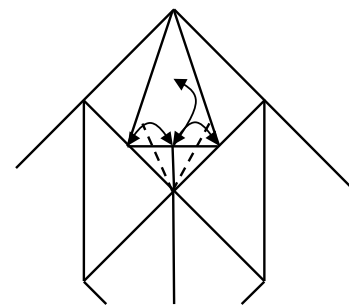

8. Zegnij i rozprostuj rogi, a potem zegnij do góry.
Make creases and then fold up.

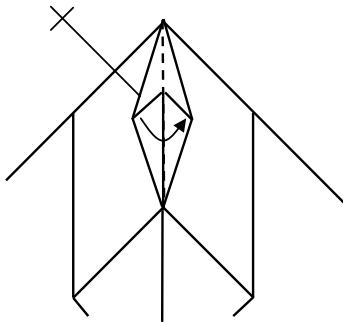

9. Zegnij w pół. Powtórz z lewej strony.
Fold in a half. Repeat on the left side.

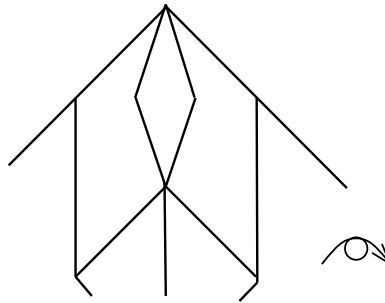

10. Odwróć model.
Turn the model over.

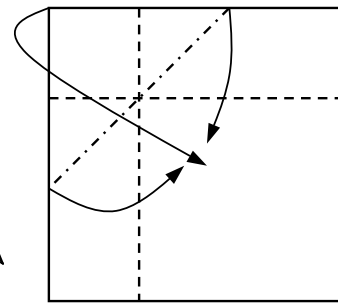

11. Zegnij do środka tworząc z rogu kwadrat.
Fold to the center along the existing creases. Create a square in the corner.

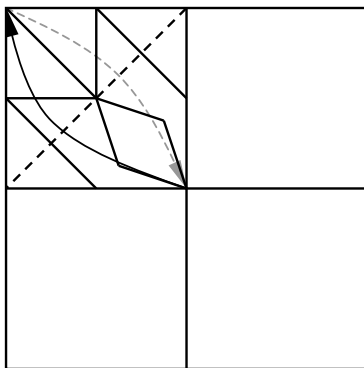

12. Zegnij kwadrat do góry, równocześnie zaginając jego górną część do tyłu.
Fold the square up. The upper part of the square will lay behind.

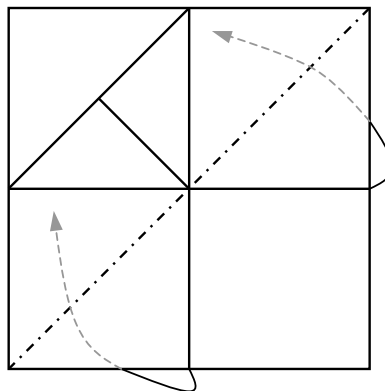

13. Złóż do środka.
Inside reverse fold.

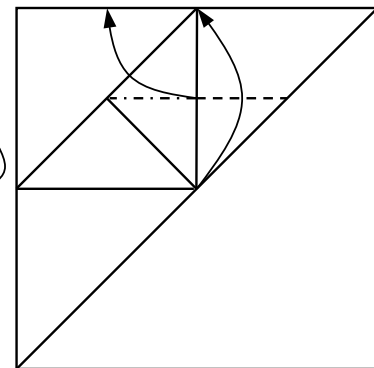

14. Złóż do góry.
Fold up.

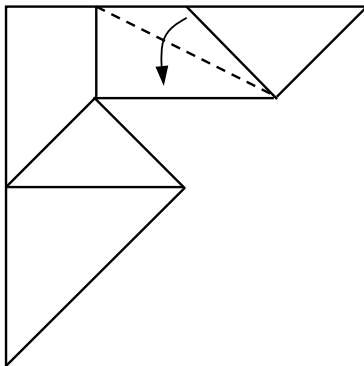

15. Złóż w dół.
Fold down.

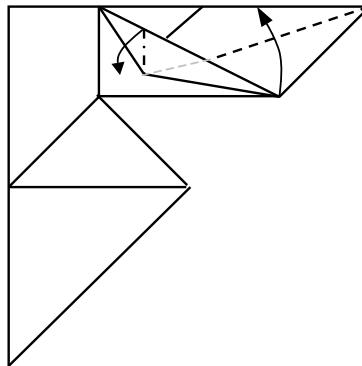

16. Zwęż tę część.
Narrow this part.

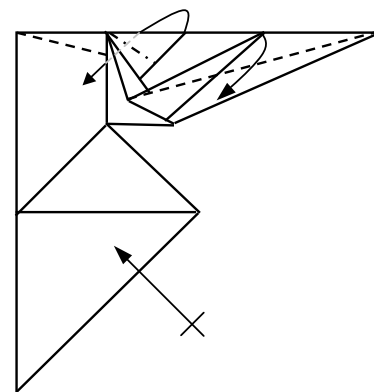

17. Wsuń do środka jedną część, a drugą zegnij w dół. Powtórz kroki 14 – 17 z lewej strony.
Fold one layer inside and the other just fold down. Repeat 14 – 17 steps on the left side.

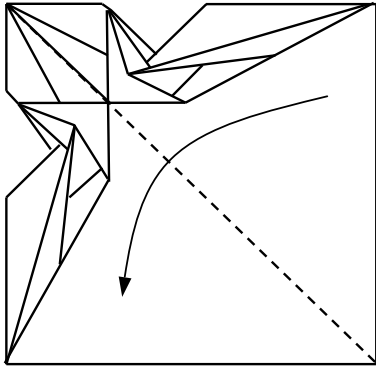

18. Zegnij w pół.
Fold in a half.

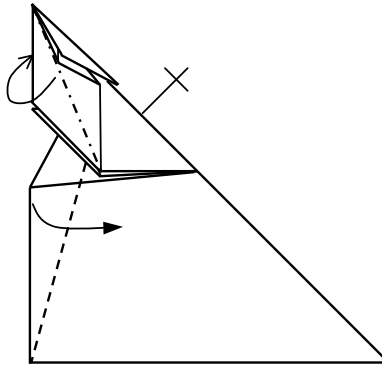

19. Zwęź głowę zginając pod spód i nogi zginając w bok. Powtórz z drugiej strony.
Narrow the head (fold underneath) and the leg (valley fold). Repeat behind.

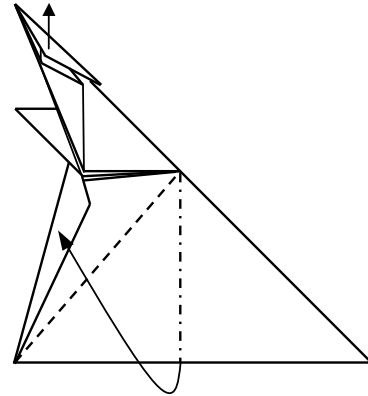

20. Pociągnij za głowę i przesun ją do góry i prawo. Złóż dolną część w kwadrat.
Pull the head and move it up and right. Make a square at the lower part of the paper.

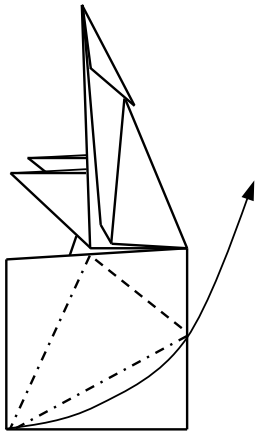

21. Zgięcie do góry.
Petal fold.

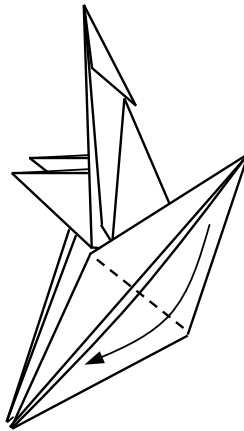

22. Złóż.
Valley fold.

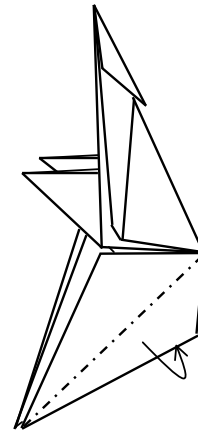

23. Zegnij do tyłu odstającą część.
Mountain fold.

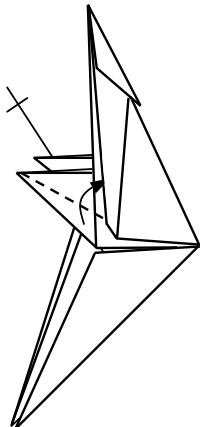

24. Zwęź łapę zginając pod spód. Powtórz z tyłu.
Narrow the paw (hide under the upper layer). Repeat behind.

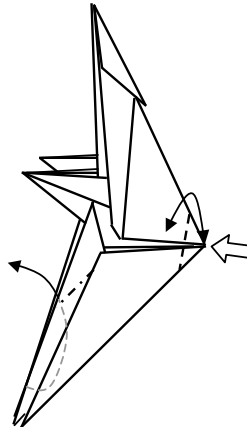

25. Zegnij nogę w bok. Wgnieć do środka garb.
Valley fold of the front leg. Sink the hump.

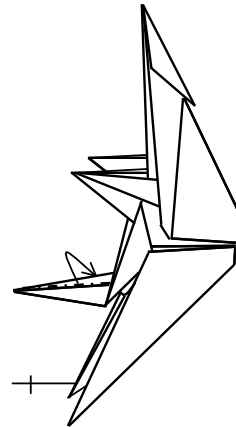

26. Zwęź nogę. Powtórz to samo z drugą nogą, ale odegnij ją słabiej.
Narrow the leg. Do the same with the second leg (fold it no so far).

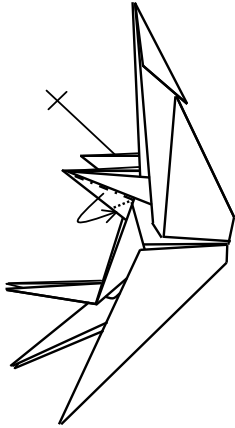

27. Zwęż łapy wyginając ich dolną część do środka.
Narrow paws with the inside reverse fold.

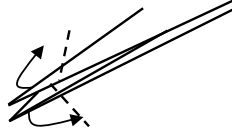

28. Uformuj nogi: rozłóż końcówki na dwie części.
Shape legs: fold tops.

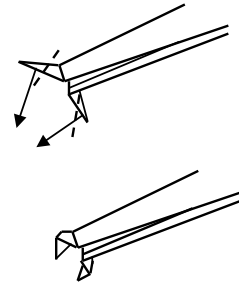

29. Zrób pazury.
Możesz pozostawić nie zgięte pazury, żeby poprawić stabilność modelu.
Make claws.
Leave the claws unfold to make the model more stable.

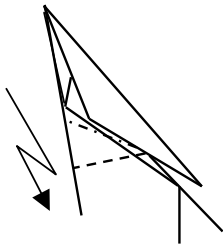

30. Zegnij głowę w dół.
Fold the head down.

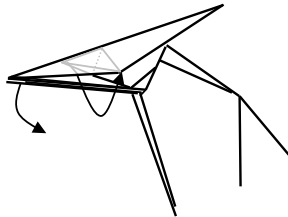

31. Otwórz pyszczek i uformuj oczy.
Open mouth and shape eyes.

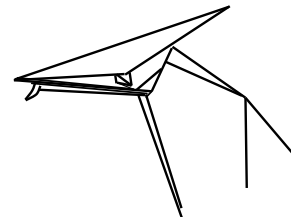

32.

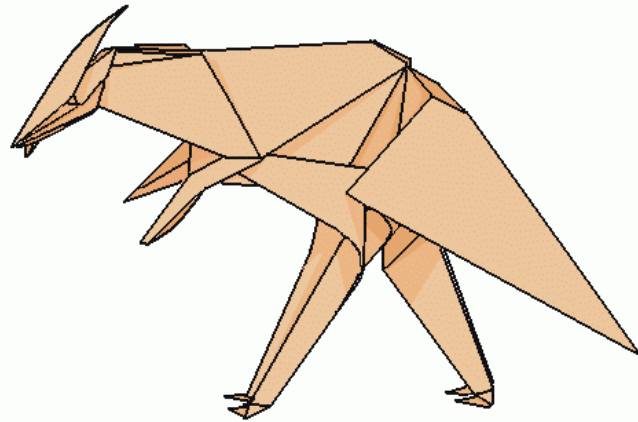

33. Gotowe. Completed.